

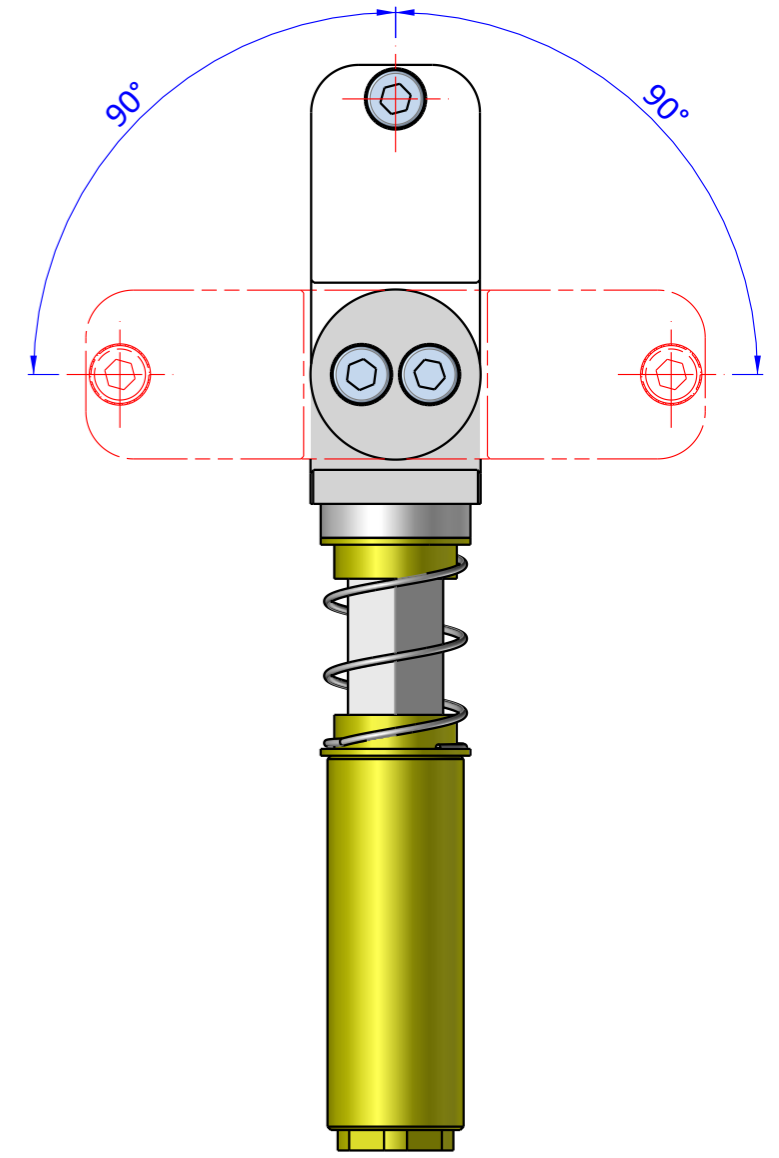

THE PROPERTY OF THE DRAWING IS ESTABLISHED BY LAW. IT IS FORBIDDEN TO PRODUCE OR SHOW IT TO THIRD PART. WITHOUT A WRITTEN AGREEMENT.

Item	Name	Q.ty
1	GVR.20.2	1
2	GVR.20.3	1
3	M.21x44	1
4	R.5.SCH	3
5	SAE.20141825.2	1
6	SAE.20141825.3	1
7	SAE.20141825.4	2
8	SAE.20141825.5	1
9	SAM.2020.1	1
10	V.TCE5x25	3

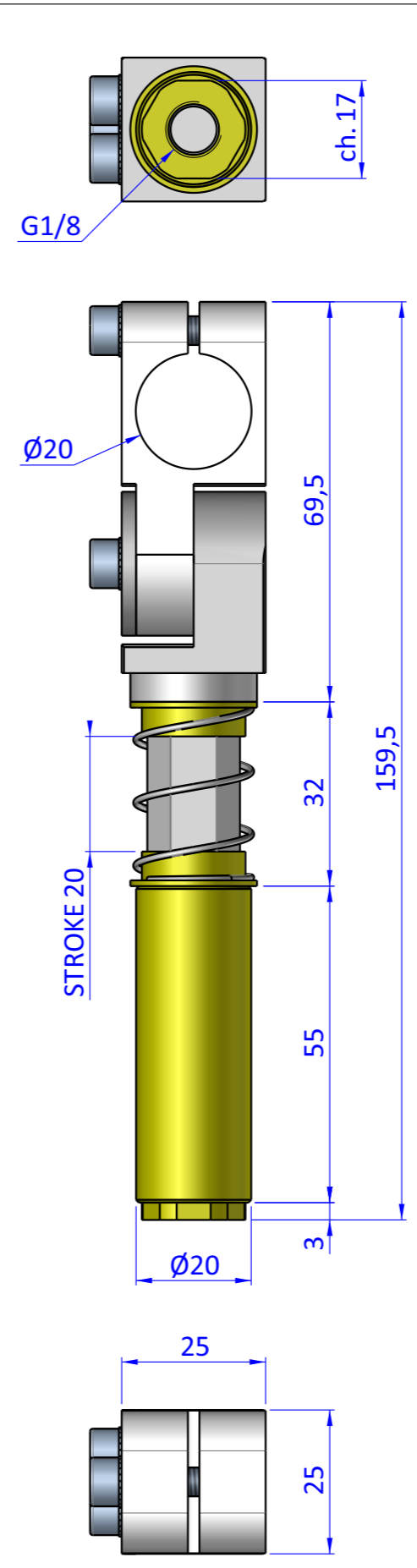
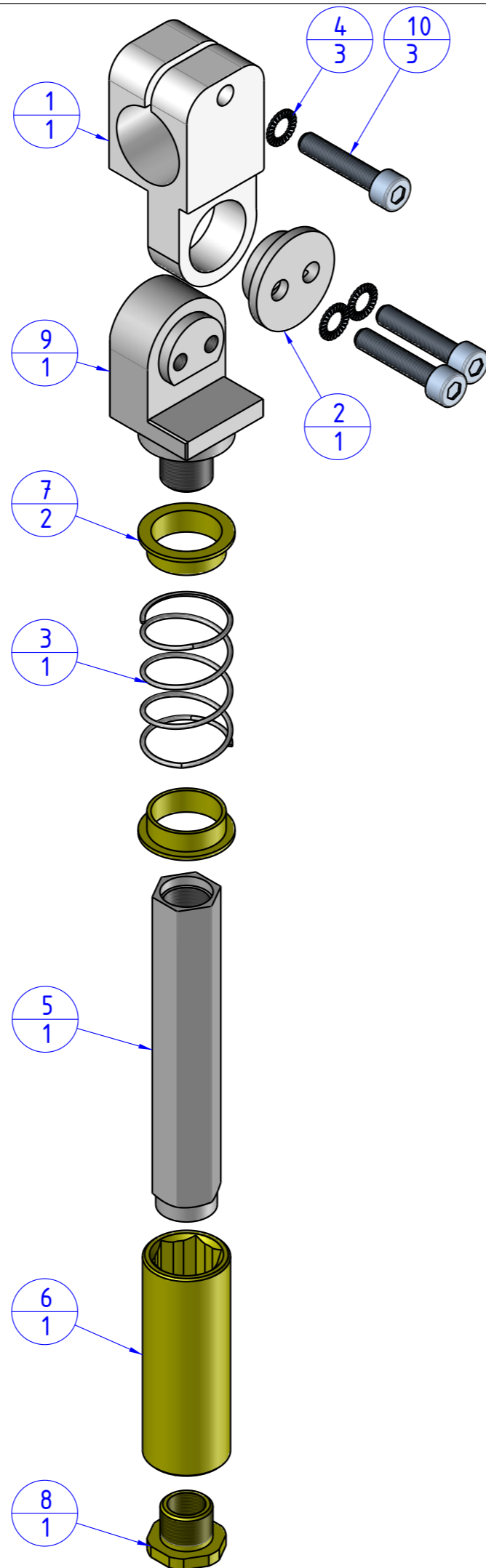

Format A3  
UNI 936-76

 <b>FPS</b> FPSERVICES AUTOMATION		DESIGNED FROM		REVIEW
		FPS Automation		A
GENERAL TOLERANCE		DATE	WEIGHT	
UNI - ISO 2768		24/01/2022	0,168kg	
CLASSE f		CODE		
		CA.SAM.202520		CA.SAM.202520